

# 0.1%, 25ppm, SC70 Shunt Voltage Reference with Multiple Reverse Breakdown Voltages

## General Description

The MAX6138 is a precision, two-terminal shunt mode, bandgap voltage reference available in fixed reverse breakdown voltages of 1.2205V, 2.048V, 2.5V, 3.0V, 3.3V, 4.096V, and 5.0V. Ideal for space-critical applications, the MAX6138 is offered in the subminiature 3-pin SC70 surface-mount package (1.8mm X 1.8mm), 50% smaller than comparable devices in SOT23 surface-mount packages.

Laser-trimmed resistors ensure precise initial accuracy. With a 25ppm/°C temperature coefficient, the device is offered in three grades of initial accuracy ranging from 0.1% to 0.5%. The MAX6138 has a 60µA to 15mA shunt-current capability with low-dynamic impedance, ensuring stable reverse breakdown voltage accuracy over a wide range of operating temperatures and currents.

The MAX6138 does not require an external stabilizing capacitor while ensuring stability with capacitive loads. The MAX6138 is a higher precision device in a smaller package than the LM4040/LM4050.

## Applications

Portable, Battery-Powered Equipment  
 Notebook Computers  
 Cell Phones  
 Industrial Process Control

## Pin Configuration

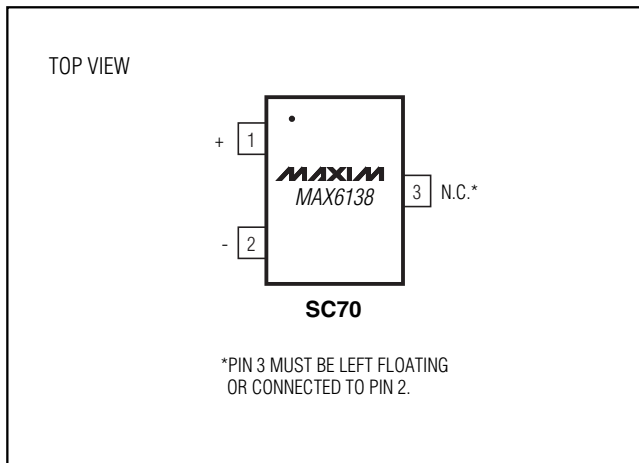

## Features

- ◆ Ultra-Small 3-Pin SC70 Package
- ◆ 0.1% (max) Initial Accuracy
- ◆ 25ppm/°C (max) Temperature Coefficient  
Guaranteed Over -40°C to +85°C Temperature Range
- ◆ Wide Operating Current Range: 60µA to 15mA
- ◆ Low 28µVRMS Output Noise (10Hz to 10kHz)
- ◆ 1.2205V, 2.048V, 2.5V, 3.0V, 3.3V, 4.096V, and 5.0V Fixed Reverse Breakdown Voltages
- ◆ No Output Capacitors Required
- ◆ Stable with Capacitive Loads

## Selector Guide

| PART            | TEMP RANGE     | PIN-PACKAGE | OUTPUT VOLTAGE (V) |
|-----------------|----------------|-------------|--------------------|
| MAX6138_EXR12-T | -40°C to +85°C | 3 SC70-3    | 1.2205             |
| MAX6138_EXR21-T | -40°C to +85°C | 3 SC70-3    | 2.0480             |
| MAX6138_EXR25-T | -40°C to +85°C | 3 SC70-3    | 2.5000             |
| MAX6138_EXR30-T | -40°C to +85°C | 3 SC70-3    | 3.0000             |
| MAX6138_EXR33-T | -40°C to +85°C | 3 SC70-3    | 3.3000             |
| MAX6138_EXR41-T | -40°C to +85°C | 3 SC70-3    | 4.0960             |
| MAX6138_EXR50-T | -40°C to +85°C | 3 SC70-3    | 5.0000             |

Ordering Information appears at end of data sheet.

## Typical Operating Circuit

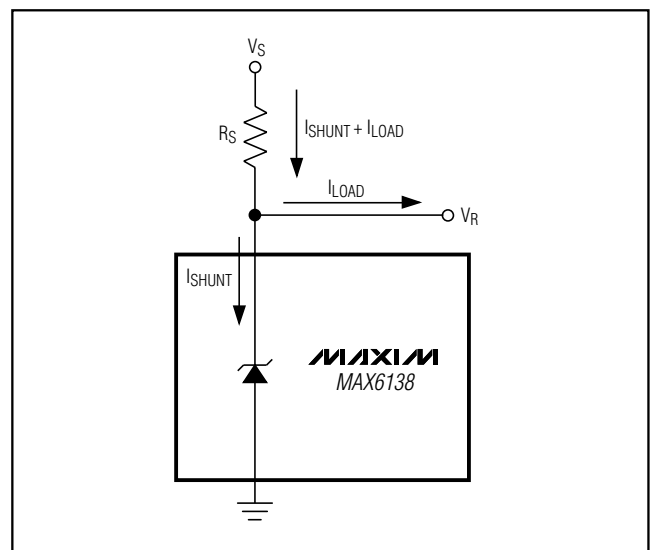

# 0.1%, 25ppm, SC70 Shunt Voltage Reference with Multiple Reverse Breakdown Voltages

## ABSOLUTE MAXIMUM RATINGS

|   |       |   |                 |
|---|-------|---|-----------------|
| Reverse Current (cathode to anode) .....              | 20mA  | Operating Temperature Range .....       | -40°C to +125°C |
| Forward Current (anode to cathode) .....              | 10mA  | Storage Temperature Range .....         | -65°C to +150°C |
| Continuous Power Dissipation (T <sub>A</sub> = +70°C) |       | Junction Temperature .....              | +150°C          |
| 3-Pin SC70 (derate 2.17mW/°C above +70°C) .....       | 174mW | Lead Temperature (soldering, 10s) ..... | +300°C          |

Stresses beyond those listed under "Absolute Maximum Ratings" may cause permanent damage to the device. These are stress ratings only, and functional operation of the device at these or any other conditions beyond those indicated in the operational sections of the specifications is not implied. Exposure to absolute maximum rating conditions for extended periods may affect device reliability.

## ELECTRICAL CHARACTERISTICS—MAX6138\_12 (1.2205V)

(I<sub>R</sub> = 100μA, T<sub>A</sub> = -40°C to +85°C, unless otherwise noted. Typical values are at T<sub>A</sub> = +25°C.) (Note 1)

| PARAMETER  | SYMBOL                           | CONDITIONS   | MIN             | TYP    | MAX    | UNITS             |   |
|--|----------------------------------|--|-----------------|--------|--------|-------------------|---|
| Reverse Breakdown Voltage (Note 2)                             | V <sub>R</sub>                   | T <sub>A</sub> = +25°C   | MAX6138A (0.1%) | 1.2193 | 1.2205 | 1.2217            | V |
|  |                                  |  | MAX6138B (0.2%) | 1.2181 | 1.2205 | 1.2229            |   |
|  |                                  |  | MAX6138C (0.5%) | 1.2144 | 1.2205 | 1.2266            |   |
| Minimum Operating Current                                      | I <sub>RMIN</sub>                |  |                 | 45     | 60     | μA                |   |
| Reverse Voltage Temperature Coefficient (Notes 2, 3)           | TC                               |  |                 | 4      | 25     | ppm/°C            |   |
| Reverse Breakdown Voltage Change with Operating Current Change | ΔV <sub>R</sub> /ΔI <sub>R</sub> | I <sub>RMIN</sub> ≤ I <sub>R</sub> ≤ 1mA                             |                 | 0.3    | 1.0    | mV                |   |
|  |                                  | 1mA ≤ I <sub>R</sub> ≤ 12mA  |                 | 2.5    | 8.0    |                   |   |
| Reverse Dynamic Impedance (Note 3)                             | Z <sub>R</sub>                   | I <sub>R</sub> = 1mA, f = 120Hz, I <sub>AC</sub> = 0.1I <sub>R</sub> |                 | 0.3    | 0.8    | Ω                 |   |
| Wideband Noise   | e <sub>N</sub>                   | I <sub>R</sub> = 10μA, 10Hz ≤ f ≤ 10kHz                              |                 | 20     |        | μV <sub>RMS</sub> |   |
| Reverse Breakdown Voltage                                      | ΔV <sub>R</sub>                  | t = 1000h  |                 | 120    |        | ppm               |   |

# 0.1%, 25ppm, SC70 Shunt Voltage Reference with Multiple Reverse Breakdown Voltages

**MAX6138**

## ELECTRICAL CHARACTERISTICS—MAX6138\_21 (2.048V)

( $I_R = 100\mu\text{A}$ ,  $T_A = -40^\circ\text{C}$  to  $+85^\circ\text{C}$ , unless otherwise noted. Typical values are at  $T_A = +25^\circ\text{C}$ .) (Note 1)

| PARAMETER  | SYMBOL                  | CONDITIONS  |                 | MIN    | TYP    | MAX    | UNITS                 |
|--|-------------------------|---|-----------------|--------|--------|--------|-----------------------|
| Reverse Breakdown Voltage (Note 2)                             | $V_R$                   | $T_A = +25^\circ\text{C}$                                   | MAX6138A (0.1%) | 2.0460 | 2.0480 | 2.0500 | V                     |
|  |                         |   | MAX6138B (0.2%) | 2.0439 | 2.0480 | 2.0521 |                       |
|  |                         |   | MAX6138C (0.5%) | 2.0378 | 2.0480 | 2.0582 |                       |
| Minimum Operating Current                                      | $I_{RMIN}$              |   |                 | 45     | 65     |        | $\mu\text{A}$         |
| Reverse Voltage Temperature Coefficient (Notes 2, 3)           | TC                      |   |                 |        | 4      | 25     | ppm/ $^\circ\text{C}$ |
| Reverse Breakdown Voltage Change with Operating Current Change | $\Delta V_R/\Delta I_R$ | $I_{RMIN} \leq I_R \leq 1\text{mA}$                         |                 |        | 0.3    | 1.0    | mV                    |
|  |                         | $1\text{mA} \leq I_R \leq 15\text{mA}$                      |                 |        | 2.5    | 8.0    |                       |
| Reverse Dynamic Impedance (Note 3)                             | $Z_R$                   | $I_R = 1\text{mA}$ , $f = 120\text{Hz}$ , $I_{AC} = 0.1I_R$ |                 |        | 0.3    | 0.8    | $\Omega$              |
| Wideband Noise   | $e_N$                   | $10\text{Hz} \leq f \leq 10\text{kHz}$                      |                 |        | 28     |        | $\mu\text{VRMS}$      |
| Reverse Breakdown Voltage Long-Term Stability                  | $\Delta V_R$            | $t = 1000\text{h}$  |                 |        | 120    |        | ppm                   |

## ELECTRICAL CHARACTERISTICS—MAX6138\_25 (2.5V)

( $I_R = 100\mu\text{A}$ ,  $T_A = -40^\circ\text{C}$  to  $+85^\circ\text{C}$ , unless otherwise noted. Typical values are at  $T_A = +25^\circ\text{C}$ .) (Note 1)

| PARAMETER  | SYMBOL                  | CONDITIONS  |                 | MIN    | TYP    | MAX    | UNITS                 |
|--|-------------------------|---|-----------------|--------|--------|--------|-----------------------|
| Reverse Breakdown Voltage (Note 2)                             | $V_R$                   | $T_A = +25^\circ\text{C}$                                   | MAX6138A (0.1%) | 2.4975 | 2.5000 | 2.5025 | V                     |
|  |                         |   | MAX6138B (0.2%) | 2.4950 | 2.5000 | 2.5050 |                       |
|  |                         |   | MAX6138C (0.2%) | 2.4875 | 2.5000 | 2.5125 |                       |
| Minimum Operating Current                                      | $I_{RMIN}$              |   |                 | 45     | 65     |        | $\mu\text{A}$         |
| Reverse Voltage Temperature Coefficient (Notes 2, 3)           | TC                      |   |                 |        | 4      | 25     | ppm/ $^\circ\text{C}$ |
| Reverse Breakdown Voltage Change with Operating Current Change | $\Delta V_R/\Delta I_R$ | $I_{RMIN} \leq I_R \leq 1\text{mA}$                         |                 |        | 0.3    | 1.0    | mV                    |
| Reverse Breakdown Voltage Change with Operating Current Change | $\Delta V_R/\Delta I_R$ | $1\text{mA} \leq I_R \leq 15\text{mA}$                      |                 |        | 2.5    | 8.0    | mV                    |
| Reverse Dynamic Impedance (Note 3)                             | $Z_R$                   | $I_R = 1\text{mA}$ , $f = 120\text{Hz}$ , $I_{AC} = 0.1I_R$ |                 |        | 0.3    | 0.8    | $\Omega$              |
| Wideband Noise   | $e_N$                   | $10\text{Hz} \leq f \leq 10\text{kHz}$                      |                 |        | 35     |        | $\mu\text{VRMS}$      |
| Reverse Breakdown Voltage Long-Term Stability                  | $\Delta V_R$            | $t = 1000\text{h}$  |                 |        | 120    |        | ppm                   |

# 0.1%, 25ppm, SC70 Shunt Voltage Reference with Multiple Reverse Breakdown Voltages

## ELECTRICAL CHARACTERISTICS—MAX6138\_30 (3.0V)

( $I_R = 100\mu\text{A}$ ,  $T_A = -40^\circ\text{C}$  to  $+85^\circ\text{C}$ , unless otherwise noted. Typical values are at  $T_A = +25^\circ\text{C}$ .) (Note 1)

| PARAMETER  | SYMBOL                  | CONDITIONS  | MIN             | TYP    | MAX    | UNITS                 |   |
|--|-------------------------|---|-----------------|--------|--------|-----------------------|---|
| Reverse Breakdown Voltage (Note 2)                             | $V_R$                   | $T_A = +25^\circ\text{C}$                                   | MAX6138A (0.1%) | 2.9970 | 3.0000 | 3.0030                | V |
|  |                         |   | MAX6138B (0.2%) | 2.9940 | 3.0000 | 3.0060                |   |
|  |                         |   | MAX6138C (0.5%) | 2.9850 | 3.0000 | 3.0150                |   |
| Minimum Operating Current                                      | $I_{RMIN}$              |   |                 | 45     | 65     | $\mu\text{A}$         |   |
| Reverse Voltage Temperature Coefficient (Notes 2, 3)           | TC                      |   |                 | 4      | 25     | ppm/ $^\circ\text{C}$ |   |
| Reverse Breakdown Voltage Change with Operating Current Change | $\Delta V_R/\Delta I_R$ | $I_{RMIN} \leq I_R \leq 1\text{mA}$                         |                 | 0.3    | 1.0    | mV                    |   |
|  |                         | $1\text{mA} \leq I_R \leq 15\text{mA}$                      |                 | 2.5    | 8.0    |                       |   |
| Reverse Dynamic Impedance (Note 3)                             | $Z_R$                   | $I_R = 1\text{mA}$ , $f = 120\text{Hz}$ , $I_{AC} = 0.1I_R$ |                 | 0.3    | 0.8    | $\Omega$              |   |
| Wideband Noise   | $e_N$                   | $10\text{Hz} \leq f \leq 10\text{kHz}$                      |                 | 45     |        | $\mu\text{VRMS}$      |   |
| Reverse Breakdown Voltage Long-Term Stability                  | $\Delta V_R$            | $t = 1000\text{h}$  |                 | 120    |        | ppm                   |   |

## ELECTRICAL CHARACTERISTICS—MAX6138\_33 (3.3V)

( $I_R = 100\mu\text{A}$ ,  $T_A = -40^\circ\text{C}$  to  $+85^\circ\text{C}$ , unless otherwise noted. Typical values are at  $T_A = +25^\circ\text{C}$ .) (Note 1)

| PARAMETER  | SYMBOL                  | CONDITIONS  | MIN             | TYP    | MAX    | UNITS                 |   |
|--|-------------------------|---|-----------------|--------|--------|-----------------------|---|
| Reverse Breakdown Voltage (Note 2)                             | $V_R$                   | $T_A = +25^\circ\text{C}$                                   | MAX6138A (0.1%) | 3.2967 | 3.3000 | 3.3033                | V |
|  |                         |   | MAX6138B (0.2%) | 3.2934 | 3.3000 | 3.3066                |   |
|  |                         |   | MAX6138C (0.5%) | 3.2835 | 3.3000 | 3.3165                |   |
| Minimum Operating Current                                      | $I_{RMIN}$              |   |                 | 45     | 67     | $\mu\text{A}$         |   |
| Reverse Voltage Temperature Coefficient (Notes 2, 3)           | TC                      |   |                 | 4      | 25     | ppm/ $^\circ\text{C}$ |   |
| Reverse Breakdown Voltage Change with Operating Current Change | $\Delta V_R/\Delta I_R$ | $I_{RMIN} \leq I_R \leq 1\text{mA}$                         |                 | 0.3    | 1.0    | mV                    |   |
|  |                         | $1\text{mA} \leq I_R \leq 15\text{mA}$                      |                 |        | 8.0    |                       |   |
| Reverse Dynamic Impedance (Note 3)                             | $Z_R$                   | $I_R = 1\text{mA}$ , $f = 120\text{Hz}$ , $I_{AC} = 0.1I_R$ |                 | 0.3    | 0.8    | $\Omega$              |   |
| Wideband Noise   | $e_N$                   | $10\text{Hz} \leq f \leq 10\text{kHz}$                      |                 | 50     |        | $\mu\text{VRMS}$      |   |
| Reverse Breakdown Voltage Long-Term Stability                  | $\Delta V_R$            | $t = 1000\text{h}$  |                 | 120    |        | ppm                   |   |

# 0.1%, 25ppm, SC70 Shunt Voltage Reference with Multiple Reverse Breakdown Voltages

MAX6138

## ELECTRICAL CHARACTERISTICS—MAX6138\_41 (4.096V)

( $I_R = 100\mu A$ ,  $T_A = -40^\circ C$  to  $+85^\circ C$ , unless otherwise noted. Typical values are at  $T_A = +25^\circ C$ .) (Note 1)

| PARAMETER  | SYMBOL                    | CONDITIONS                                    | MIN             | TYP    | MAX    | UNITS           |   |
|--|---------------------------|---|-----------------|--------|--------|-----------------|---|
| Reverse Breakdown Voltage (Note 2)                             | $V_R$                     | $T_A = +25^\circ C$                           | MAX6138A (0.1%) | 4.0919 | 4.0960 | 4.1001          | V |
|  |                           |   | MAX6138B (0.2%) | 4.0878 | 4.0960 | 4.1042          |   |
|  |                           |   | MAX6138C (0.5%) | 4.0755 | 4.0960 | 4.1165          |   |
| Minimum Operating Current                                      | $I_{RMIN}$                |   |                 | 50     | 73     | $\mu A$         |   |
| Reverse Voltage Temperature Coefficient (Notes 2, 3)           | TC                        |   |                 | 4      | 25     | ppm/ $^\circ C$ |   |
| Reverse Breakdown Voltage Change with Operating Current Change | $\Delta V_R / \Delta I_R$ | $I_{RMIN} \leq I_R \leq 1mA$                  |                 | 0.5    | 1.2    | mV              |   |
|  |                           | $1mA \leq I_R \leq 15mA$                      |                 | 3.0    | 10.0   |                 |   |
| Reverse Dynamic Impedance (Note 3)                             | $Z_R$                     | $I_R = 1mA$ , $f = 120Hz$ , $I_{AC} = 0.1I_R$ |                 | 0.5    | 1.0    | $\Omega$        |   |
| Wideband Noise   | $e_N$                     | $10Hz \leq f \leq 10kHz$                      |                 | 64     |        | $\mu V_{RMS}$   |   |
| Reverse Breakdown Voltage Long-Term Stability                  | $\Delta V_R$              | $t = 1000h$                                   |                 | 120    |        | ppm             |   |

## ELECTRICAL CHARACTERISTICS—MAX6138\_50 (5.0V)

( $I_R = 100\mu A$ ,  $T_A = -40^\circ C$  to  $+85^\circ C$ , unless otherwise noted. Typical values are at  $T_A = +25^\circ C$ .) (Note 1)

| PARAMETER  | SYMBOL                    | CONDITIONS                                    | MIN             | TYP    | MAX    | UNITS           |   |
|--|---------------------------|---|-----------------|--------|--------|-----------------|---|
| Reverse Breakdown Voltage (Note 2)                             | $V_R$                     | $T_A = +25^\circ C$                           | MAX6138A (0.1%) | 4.9950 | 5.0000 | 5.0050          | V |
|  |                           |   | MAX6138B (0.2%) | 4.9900 | 5.0000 | 5.0100          |   |
|  |                           |   | MAX6138C (0.5%) | 4.9750 | 5.0000 | 5.0250          |   |
| Minimum Operating Current                                      | $I_{RMIN}$                |   |                 | 54     | 80     | $\mu A$         |   |
| Reverse Voltage Temperature Coefficient (Notes 2, 3)           | TC                        |   |                 | 4      | 25     | ppm/ $^\circ C$ |   |
| Reverse Breakdown Voltage Change with Operating Current Change | $\Delta V_R / \Delta I_R$ | $I_{RMIN} \leq I_R \leq 1mA$                  |                 | 0.5    | 1.4    | mV              |   |
|  |                           | $1mA \leq I_R \leq 15mA$                      |                 | 3.5    | 12.0   |                 |   |
| Reverse Dynamic Impedance (Note 3)                             | $Z_R$                     | $I_R = 1mA$ , $f = 120Hz$ , $I_{AC} = 0.1I_R$ |                 | 0.5    | 1.1    | $\Omega$        |   |
| Wideband Noise   | $e_N$                     | $10Hz \leq f \leq 10kHz$                      |                 | 80     |        | $\mu V_{RMS}$   |   |
| Reverse Breakdown Voltage Long-Term Stability                  | $\Delta V_R$              | $t = 1000h$                                   |                 | 120    |        | ppm             |   |

**Note 1:** All devices are 100% production tested at  $+25^\circ C$  and are guaranteed by correlation for  $T_A = T_{MAX}$  to  $T_{MIN}$ , as specified.

**Note 2:** TC is measured by the "box" method, i.e.  $(V_{MAX} - V_{MIN}) / (T_{MAX} - T_{MIN})$

**Note 3:** Guaranteed by design.

# 0.1%, 25ppm, SC70 Shunt Voltage Reference with Multiple Reverse Breakdown Voltages

## Typical Operating Characteristics

( $I_R = 100\mu A$ ,  $T_A = +25^\circ C$ , unless otherwise noted.)

**REVERSE CHARACTERISTICS AND MINIMUM OPERATING CURRENT**

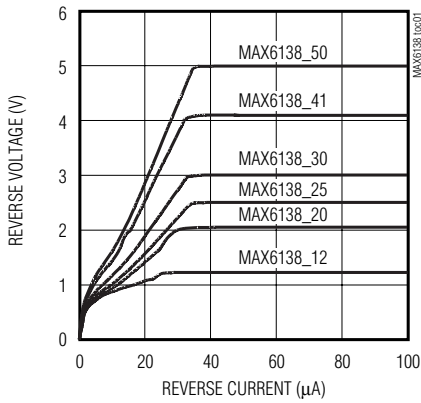

**MAX6138\_12 TEMPERATURE DRIFT**

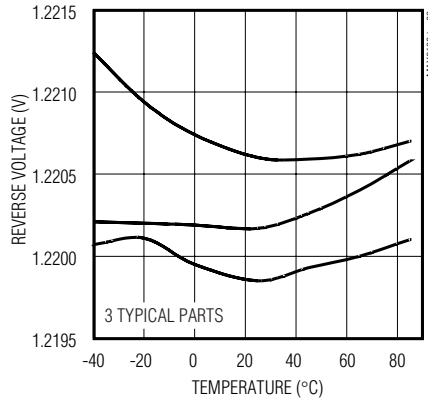

**MAX6138\_25 TEMPERATURE DRIFT**

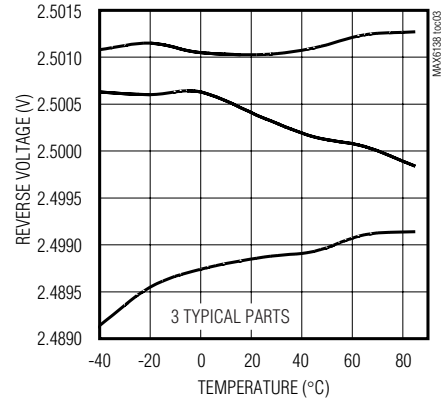

**MAX6138\_50 TEMPERATURE DRIFT**

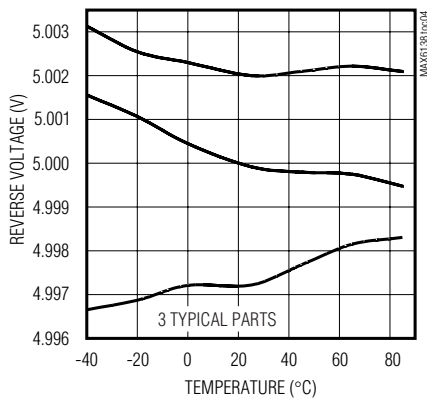

**MAX6138\_12 REVERSE VOLTAGE vs. I<sub>SHUNT</sub>**

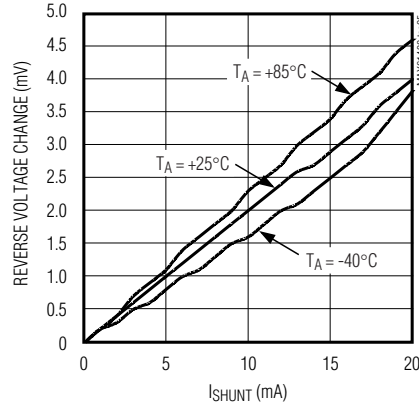

# 0.1%, 25ppm, SC70 Shunt Voltage Reference with Multiple Reverse Breakdown Voltages

## Typical Operating Characteristics (continued)

( $I_R = 100\mu\text{A}$ ,  $T_A = +25^\circ\text{C}$ , unless otherwise noted.)

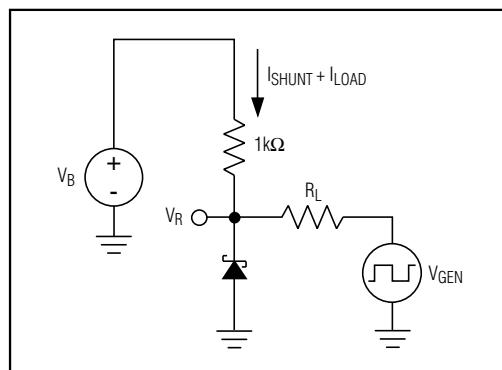
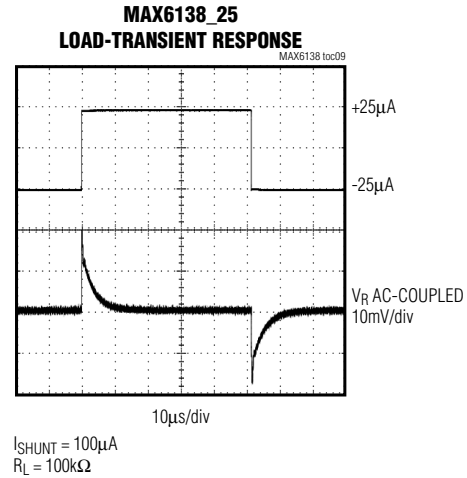
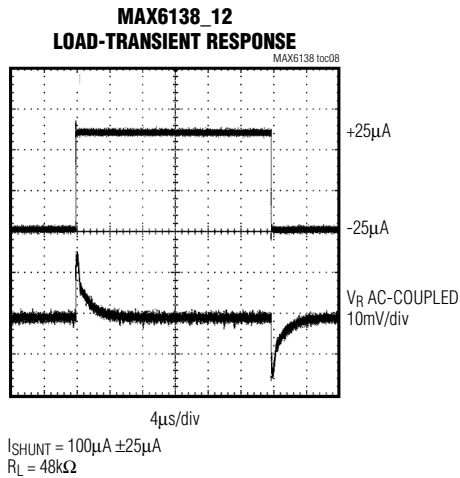
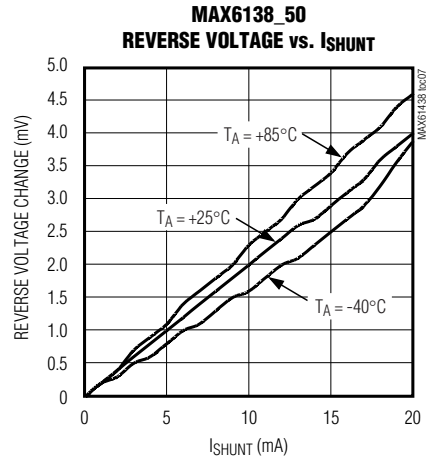
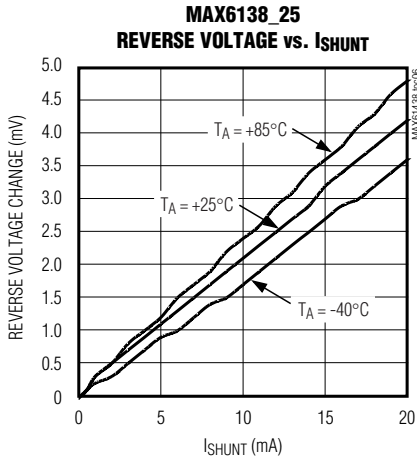

Figure 1. Load-Transient Circuit

# 0.1%, 25ppm, SC70 Shunt Voltage Reference with Multiple Reverse Breakdown Voltages

## Typical Operating Characteristics (continued)

( $I_R = 100\mu\text{A}$ ,  $T_A = +25^\circ\text{C}$ , unless otherwise noted.)

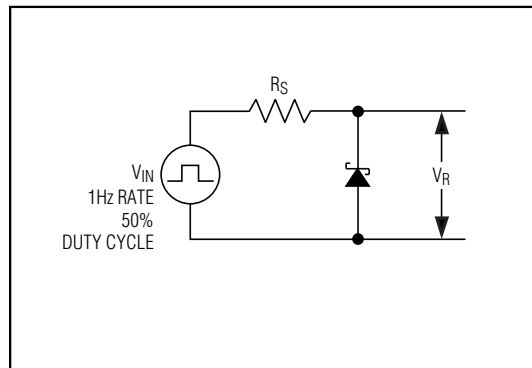
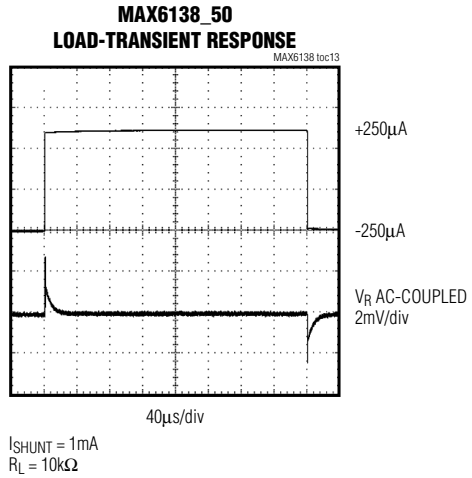
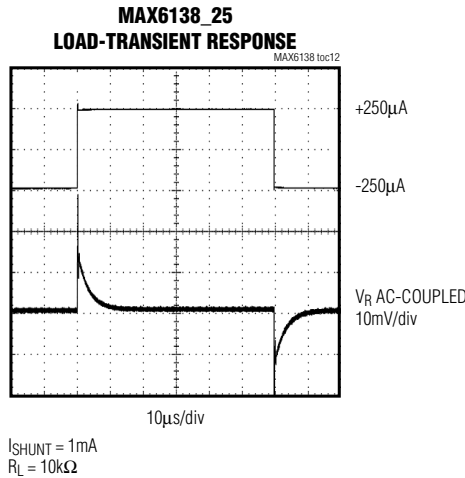
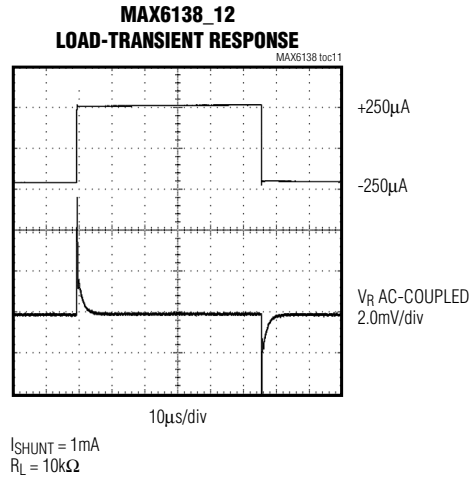
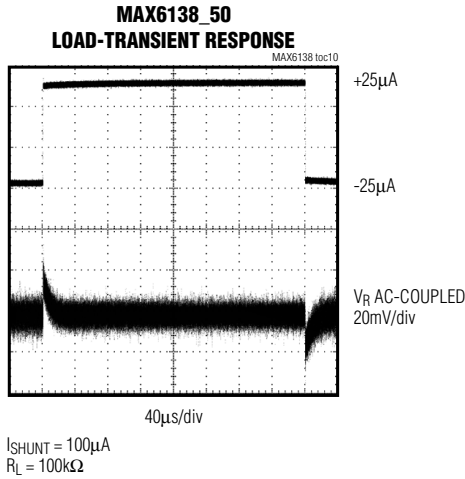

Figure 2. Startup Characteristics Test Circuit



# 0.1%, 25ppm, SC70 Shunt Voltage Reference with Multiple Reverse Breakdown Voltages

MAX6138

## Typical Operating Characteristics (continued)

( $I_R = 100\mu\text{A}$ ,  $T_A = +25^\circ\text{C}$ , unless otherwise noted.)

**MAX6138\_12**  
LOAD-TRANSIENT RESPONSE

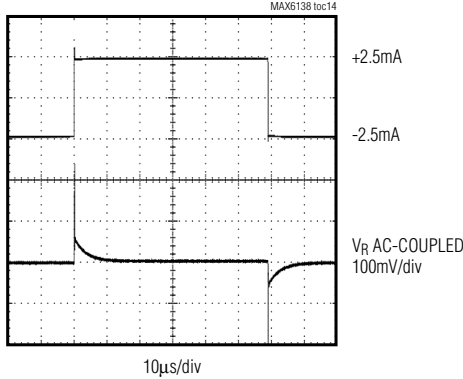

$I_{SHUNT} = 10\text{mA}$   
 $R_L = 1\text{k}\Omega$

**MAX6138\_25**  
LOAD-TRANSIENT RESPONSE

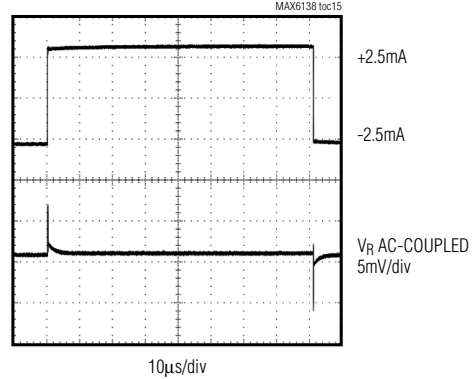

$I_{SHUNT} = 10\text{mA}$   
 $R_L = 1\text{k}\Omega$

**MAX6138\_50**  
LOAD-TRANSIENT RESPONSE

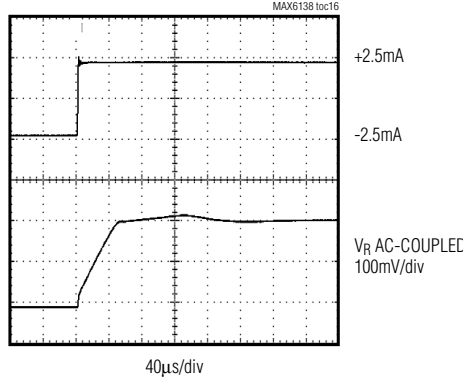

$I_{SHUNT} = 10\text{mA}$   
 $R_L = 1\text{k}\Omega$

**MAX6138\_12**  
STARTUP CHARACTERISTICS

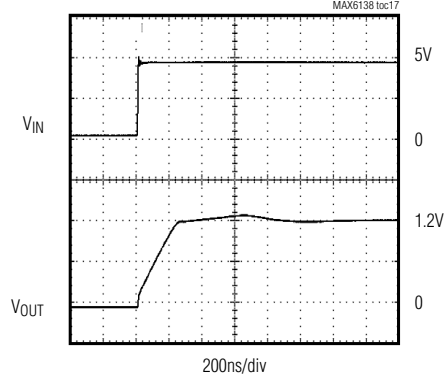

$I_{SHUNT} = 100\mu\text{A}$   
 $R_S = 30\text{k}\Omega$

**MAX6138\_25**  
STARTUP CHARACTERISTICS

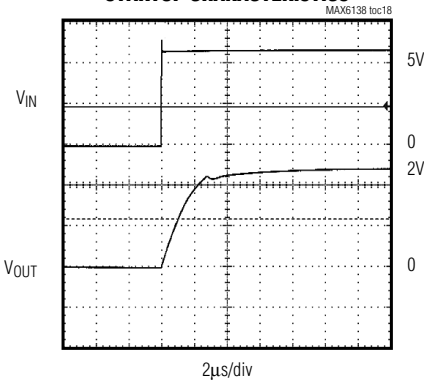

$I_{SHUNT} = 100\mu\text{A}$   
 $R_S = 30\text{k}\Omega$

**MAX6138\_50**  
STARTUP CHARACTERISTICS

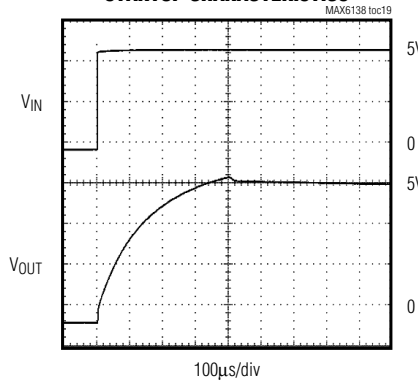

$I_{SHUNT} = 100\mu\text{A}$   
 $R_S = 16\text{k}\Omega$

**MAX6138\_12**  
OUTPUT IMPEDANCE vs. FREQUENCY

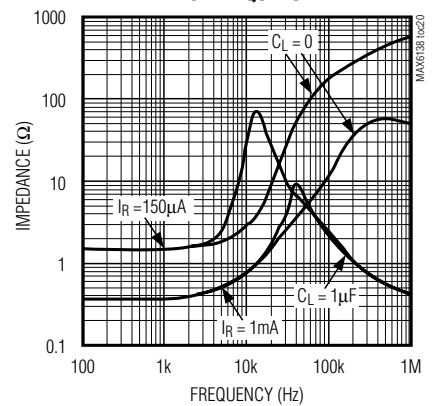

# 0.1%, 25ppm, SC70 Shunt Voltage Reference with Multiple Reverse Breakdown Voltages

## Typical Operating Characteristics (continued)

( $I_R = 100\mu A$ ,  $T_A = +25^\circ C$ , unless otherwise noted.)

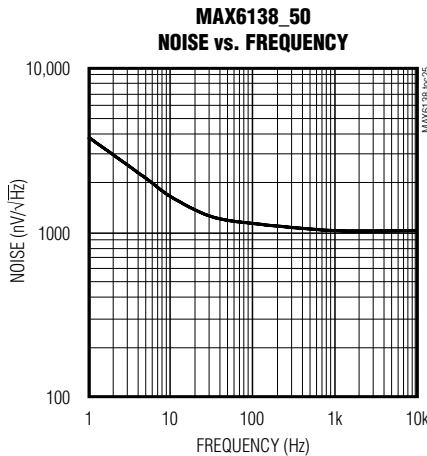
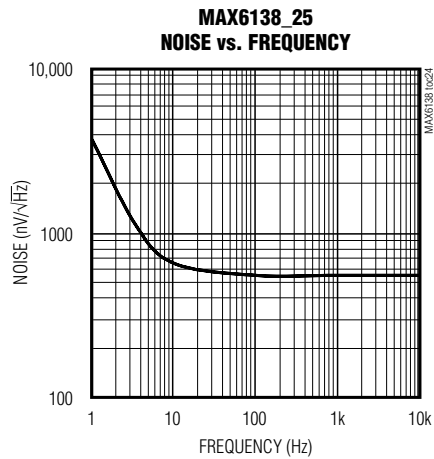
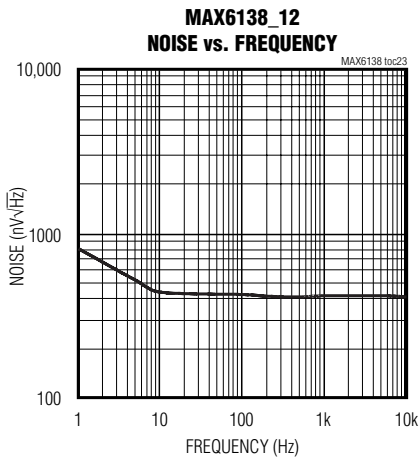
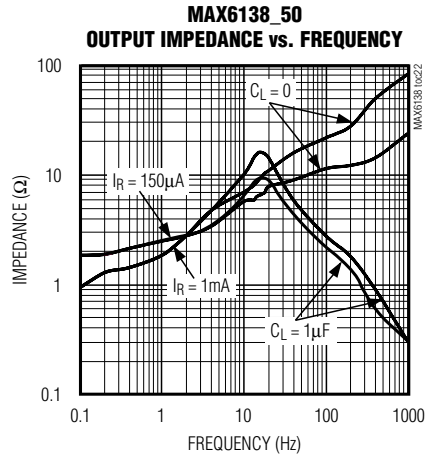
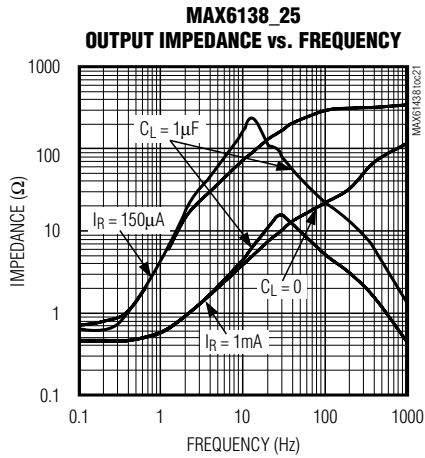

# 0.1%, 25ppm, SC70 Shunt Voltage Reference with Multiple Reverse Breakdown Voltages

## Pin Description

| PIN | NAME | FUNCTION   |
|-----|------|--|
| 1   | +    | Positive Terminal of the Shunt Reference                       |
| 2   | -    | Negative Terminal of the Shunt Reference                       |
| 3   | N.C. | No Connection. Leave this pin unconnected or connect to Pin 2. |

## Detailed Description

The MAX6138 shunt reference uses the bandgap principle to produce a stable, accurate voltage. The device behaves similarly to an ideal zener diode; a fixed voltage is maintained across its output terminals when biased with 60µA to 15mA of reverse current. The MAX6138 behaves similarly to a silicon diode when biased with forward currents up to 10mA.

Figure 3 shows a typical operating circuit. The MAX6138 is ideal for providing a stable reference from a high-voltage power supply.

## Applications Information

The MAX6138's internal pass transistor is used to maintain a constant output voltage ( $V_{SHUNT}$ ) by sinking the necessary amount of current across a source resistor. The source resistance ( $R_S$ ) is determined from the load current ( $I_{LOAD}$ ) range, supply voltage ( $V_S$ ) variations,  $V_{SHUNT}$ , and desired quiescent current.

Choose the value of  $R_S$  when  $V_S$  is at a minimum and  $I_{LOAD}$  is at a maximum. Maintain a minimum  $I_{SHUNT}$  of 60µA at all times. The  $R_S$  value should be large enough to keep  $I_{SHUNT}$  less than 15mA for proper regulation when  $V_S$  is maximum and  $I_{LOAD}$  is at a minimum. To prevent damage to the device,  $I_{SHUNT}$  should never exceed 20mA.

Therefore, the value of  $R_S$  is bounded by the following equation:

$$[V_S(\text{MIN}) - V_R] / [60\mu\text{A} + I_{LOAD(\text{MAX})}] > R_S >$$

$$[V_S(\text{MAX}) - V_R] / [20\text{mA} + I_{LOAD(\text{MIN})}]$$

Choosing a larger resistance minimizes the total power dissipation in the circuit by reducing the shunt current ( $P_{D(\text{TOTAL})} = V_S \times I_{SHUNT}$ ). Provide a safety margin to incorporate the worst-case tolerance of the resistor used. Ensure that the resistor's power rating is adequate, using the following general power equation:

$$P_{DR} = I_{SHUNT} \times (V_S(\text{MAX}) - V_{SHUNT})$$

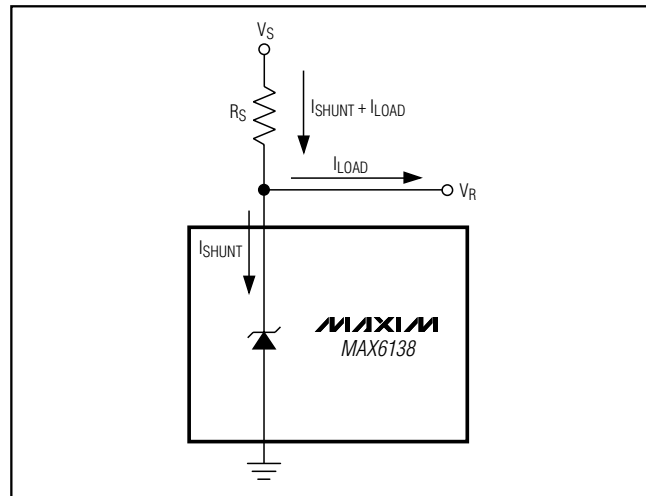

Figure 3. Typical Operating Circuit

## Output Capacitance

The MAX6138 does not require an external capacitor for operational stability and is stable for any output capacitance.

## Temperature Performance

The MAX6138 typically exhibits an output voltage temperature coefficient within  $\pm 4\text{ppm}/^\circ\text{C}$ . The polarity of the temperature coefficient may be different from one device to another; some may have positive coefficients, and others may have negative coefficients.

## Chip Information

TRANSISTOR COUNT: 70

PROCESS: BiCMOS

# 0.1%, 25ppm, SC70 Shunt Voltage Reference with Multiple Reverse Breakdown Voltages

## Ordering Information

| PART            | OUTPUT VOLTAGE (V) | INITIAL ACCURACY (%) | TEMP RANGE     | PIN-PACKAGE | TOP MARK |
|-----------------|--------------------|----------------------|----------------|-------------|----------|
| MAX6138AEXR12-T | 1.2205             | 0.1                  | -40°C to +85°C | 3 SC70-3    | AEW      |
| MAX6138BEXR12-T | 1.2205             | 0.2                  | -40°C to +85°C | 3 SC70-3    | AEX      |
| MAX6138CEXR12-T | 1.2205             | 0.5                  | -40°C to +85°C | 3 SC70-3    | AEY      |
| MAX6138AEXR21-T | 2.0480             | 0.1                  | -40°C to +85°C | 3 SC70-3    | AFA      |
| MAX6138BEXR21-T | 2.0480             | 0.2                  | -40°C to +85°C | 3 SC70-3    | AFB      |
| MAX6138CEXR21-T | 2.0480             | 0.5                  | -40°C to +85°C | 3 SC70-3    | AFC      |
| MAX6138AEXR25-T | 2.5000             | 0.1                  | -40°C to +85°C | 3 SC70-3    | AFE      |
| MAX6138BEXR25-T | 2.5000             | 0.2                  | -40°C to +85°C | 3 SC70-3    | AFF      |
| MAX6138CEXR25-T | 2.5000             | 0.5                  | -40°C to +85°C | 3 SC70-3    | AFG      |
| MAX6138AEXR30-T | 3.0000             | 0.1                  | -40°C to +85°C | 3 SC70-3    | AFI      |
| MAX6138BEXR30-T | 3.0000             | 0.2                  | -40°C to +85°C | 3 SC70-3    | AFJ      |
| MAX6138CEXR30-T | 3.0000             | 0.5                  | -40°C to +85°C | 3 SC70-3    | AFK      |
| MAX6138AEXR33-T | 3.3000             | 0.1                  | -40°C to +85°C | 3 SC70-3    | ANG      |
| MAX6138BEXR33-T | 3.3000             | 0.2                  | -40°C to +85°C | 3 SC70-3    | ANH      |
| MAX6138CEXR33-T | 3.3000             | 0.5                  | -40°C to +85°C | 3 SC70-3    | ANI      |
| MAX6138AEXR41-T | 4.0960             | 0.1                  | -40°C to +85°C | 3 SC70-3    | AFM      |
| MAX6138BEXR41-T | 4.0960             | 0.2                  | -40°C to +85°C | 3 SC70-3    | AFN      |
| MAX6138CEXR41-T | 4.0960             | 0.5                  | -40°C to +85°C | 3 SC70-3    | AFO      |
| MAX6138AEXR50-T | 5.0000             | 0.1                  | -40°C to +85°C | 3 SC70-3    | AFQ      |
| MAX6138BEXR50-T | 5.0000             | 0.2                  | -40°C to +85°C | 3 SC70-3    | AFR      |
| MAX6138CEXR50-T | 5.0000             | 0.5                  | -40°C to +85°C | 3 SC70-3    | AFS      |

# 0.1%, 25ppm, SC70 Shunt Voltage Reference with Multiple Reverse Breakdown Voltages

## Package Information

**MAX6138**

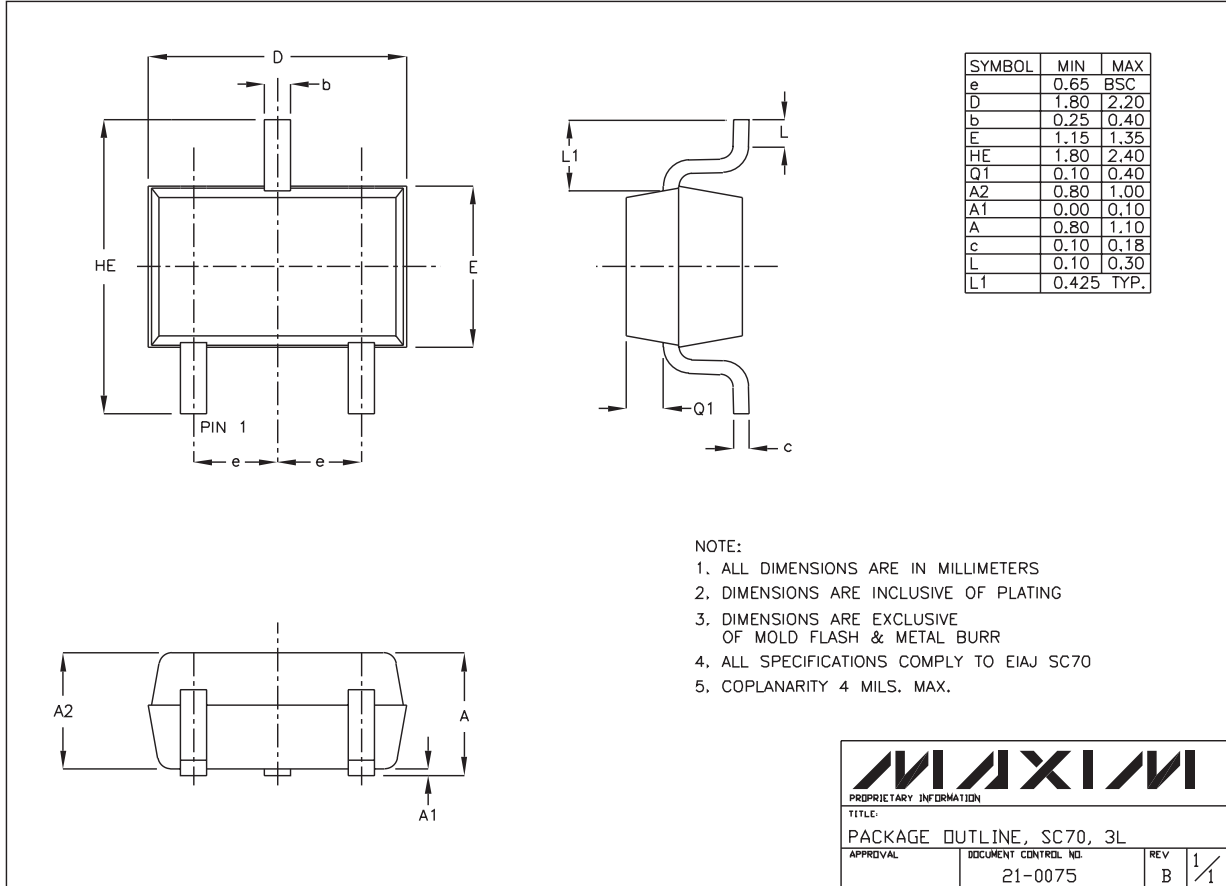

SC70, 3LEPS

Maxim cannot assume responsibility for use of any circuitry other than circuitry entirely embodied in a Maxim product. No circuit patent licenses are implied. Maxim reserves the right to change the circuitry and specifications without notice at any time.

**Maxim Integrated Products, 120 San Gabriel Drive, Sunnyvale, CA 94086 408-737-7600** \_\_\_\_\_ 13